

CASTELLO
SOFA
Made in Italy

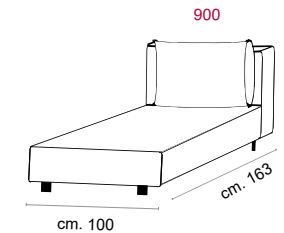

VOILA'

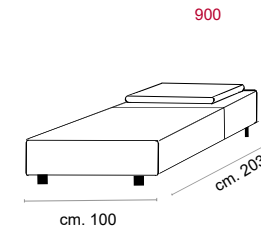

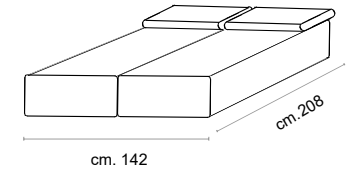
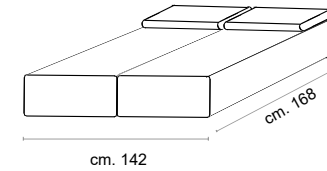
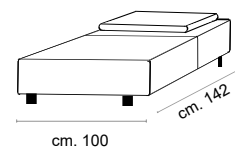
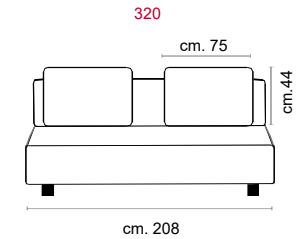
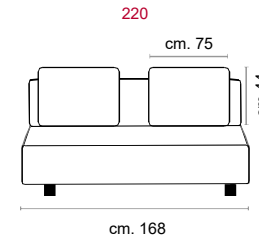
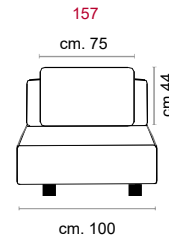
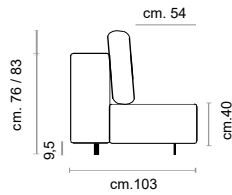

VOILA'

CS-517 Product Code

Struttura: Unico nel suo genere. L'apertura avviene mediante un meccanismo che porta la seduta in avanti con un movimento rototraslante e il successivo abbassamento dello schienale che trasforma il divano in un comodo letto.

Piano letto ortopedico con rete elettrosaldata, struttura realizzata in acciaio.

Imbottitura: Poliuretano indeformabile e ovattato faldato.

Cuscini spalliera: in fibra di poliestere a fiocchi.

Rivestimento: in tessuto, non sfoderabile.

Piede: in metallo altezza 9,5 cm colore Titanium Dark

Caratteristiche: bracciolo divano optional removibile, può essere assemblato sia su di un lato sia su ambedue i lati. Il bracciolo aumenta la larghezza del divano di 11 cm per lato.

- Bracciolo Dx codice 824

- Bracciolo Sx codice 825

Piede Slitta Optional: slitta bracciolo in metallo altezza 9 cm colore Titanium Dark

Structure: One of a kind. The opening occurs through a mechanism that brings the seat forward with a roto-translating movement and the subsequent lowering of the backrest which transforms the sofa into a comfortable bed.

Orthopedic bed base with electro welded mesh, high resistant steel structure.

Paddings: polyurethane foam and padding.

Back cushions in fibre fillings.

Covering: in fabric, not removable.

Feet: in metal 9,5 cm high Titanium Dark colour

Features: Optional removable sofa armrest, can be assembled on one or both sides. The armrest increases the width of the sofa by 11 cm for side.

- Armrest Rhf code 824

- Armrest Lhf code 825

Optional Feet Base: metal armrest base 9 cm high Titanium Dark colour

RIVESTIMENTO
COVERING STANDARD



CARATTERISTICHE
FEATURES STANDARD



BRACCIOLO - ARMREST

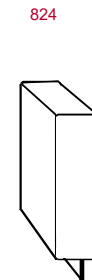
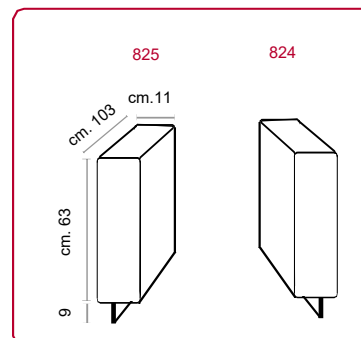

ESEMPIO COMPOSIZIONE - SECTIONALS EXAMPLE

